

PAR-30



M03PAR30-9AD with 45° tilt shown in Deep BusRun.

job name:

fixture type:

Specify: **M03PAR30** - - -

FIXTURE MODEL	ADAPTER	FINISH	ACCESSORIES (optional)
example: M03PAR30	-9A-RL	-P	-UVB/p

Museum Collection Fixtures

Fits standard 1¹³/₁₆" (46mm) and deep 2³/₈" (60mm) BusRun.

Fixture rotates up to 360° and may be ordered with an on/off switch. Includes standard tilt & rotation locks.

Accessory Cartridge is designed to be remounted in the same position after relamping, maintaining proper orientation of all accessories.

Lamp

120-volt, Incandescent
PAR-30 (by others)



Ratings

75 watts maximum



Features & Dimensions

M03PAR30-9AD-RL shown:

Flush Fit adapter with Rotation Lock *

Adapter plugs into Busway with separate electrical and mechanical connections. Electrical contacts are oversized for a long life and each fixture is fused. Adapter equipped with thumb wheel horizontal rotation lock.

Stem

Durable aluminum stem with a 1/2" (13mm) OD, features a constant tension tilt swivel that is mechanically lockable. Aiming angle is 90° maximum.

Lamp Housing

Durable aluminum housing contains a lockable accessory cartridge holder. A push-button located at the rear of the housing unlocks cartridge for rotation or removal.

Lenses and Accessories *

Standard clear or frosted lenses are available in a 55° x 75° or 5° x 55° optical pattern. Optional UV coating eliminates the need for a separate UV glass. All lenses are keyed for lockable orientation. Photo etched light blocking screens also available.

Accessory size code: p

Accessory Cartridge *

Front installation permits separate lens rotation adjustment for proper lens orientation. This optical matte black cartridge provides a built in snoot for no glare 40° cutoff and comes equipped with a cross hair baffle. Holds up to two lenses and a complete set of light blocking screens.

Finishes

Available in a durable powdercoat finish of white or matte black as well as Litelab's natural aluminum. Consult for custom finishes.

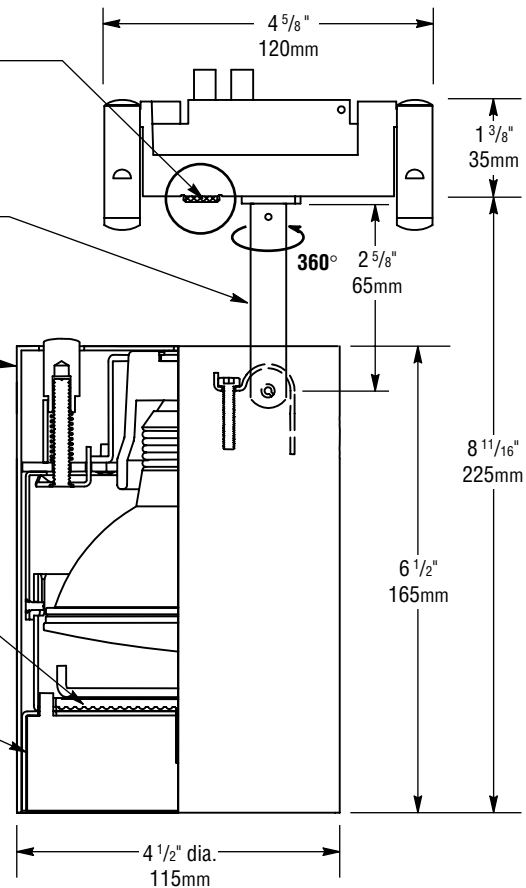

* See fittings and accessories page for mounting options and accessories.

Adapters

BusRun adapter code on-off switch rotation lock

120V & 230V REQUIRED

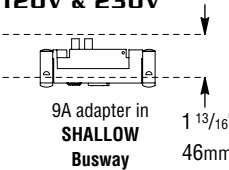

9A adapter in SHALLOW Busway 1 13/16" 46mm

9A / SY / RL
fused plug-in fitter for use with 120V BusRun busway & 120V fixtures



9E / SY / RL
fused plug-in fitter for use with 230V BusRun busway & 230V fixtures

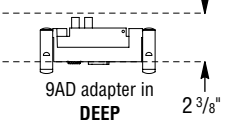

9AD adapter in DEEP Busway 2 3/8" 60mm

9AD / SY / RL
fused plug-in fitter for use with Deep 120V BusRun busway & 120V fixtures



9ED / SY / RL
fused plug-in fitter for use with Deep 230V BusRun busway & 230V fixtures

BusRun (with 75W, 12V transformer)

120V & 230V

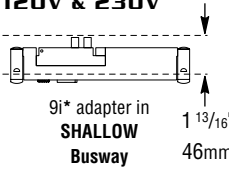

9i* adapter in SHALLOW Busway 1 13/16" 46mm

9i / SY / RL *
fused plug-in fitter with integral transformer for use with 120V BusRun busway & 12V fixtures



9iE / SY / RL *

9iE / SY / RL *
fused plug-in fitter with integral transformer for use with 230V BusRun busway & 12V fixtures

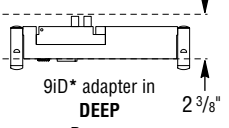

9iD* adapter in DEEP Busway 2 3/8" 60mm

9iD / SY / RL *
fused plug-in fitter with integral transformer for use with Deep 120V BusRun busway & 12V fixtures



9iED / SY / RL *

9iED / SY / RL *
fused plug-in fitter with integral transformer for use with Deep 230V BusRun busway & 12V fixtures

* U.S. Patent D499,698

Accessories

Spread Lenses

55° x 75°	5° x 55°	
OL-55x75-p-UV	OL-5x55-p-UV	UV COATED
OL-55x75-p	OL-5x55-p	UNCOATED
OL-55x75-p-FR	OL-5x55-p-FR	FROSTED

Finishes

Available in a durable powdercoat finish of white or matte black as well as Litelab's natural aluminum. Consult for custom finishes.

NT	Natural Aluminum
MB	Black
P	White
CP	Custom Paint

12V BusRun adapter code on-off switch rotation lock

REQUIRED

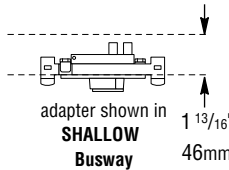

9B / SY / RL
fused plug-in fitter for use with 12V BusRun busway & 12V fixtures

120V Canopy

2

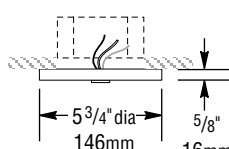

2
painted spun steel canopy, 5/8" high x 5 3/4" diameter

12V Canopy with Transformer

2E

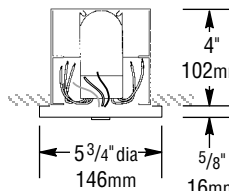

2E
painted spun steel canopy, 5/8" high x 5 3/4" diameter with integral transformer and mounting bracket for 4" x 4" x 4" box

120V MonoPoints, BusPoints

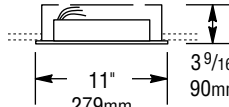

BP1D-09-NFL
3 9/16" deep integral backbox: 1 3/8" (35mm) wide canopy: 2" (51mm) wide, 11" long

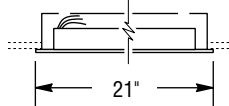

BP1D-18-NFL
3 9/16" deep integral backbox: 1 3/8" (35mm) wide canopy: 2" (51mm) wide, 21" long

UV-Filter Only

OL-FLAT-p-UV Bausch & Lomb® Optivex™ UV filter

Light-Reduction Filters

B-15N / p Photo-etched, 15% light-blocking screen
Accepts up to 5 for 30%, 45%, 60% or 75% (maximum)

Specify

FIXTURE MODEL	FITTING	FINISH	ACCESSORIES (optional)
example: M03PAR30	-9iD-RL -P	-OL-FLAT-p-UV	